

Section 8: Sound Field Systems for Schools

Guidance on Application, Purchase, Installation and Use

What is a Sound Field System?

A Sound Field System is essentially a sound amplification system. Today sound amplification is commonplace. Many terms are used to describe the different amplification systems, for example, sound reinforcement, PA, public address, paging or voice lift system. A good description for a Sound Field System might be a voice lift system.

Under quiet conditions, most people have enough natural strength in their voices to communicate with and control groups the size of school classes, even for six hours of contact time. However classroom noise can make communication difficult and a Sound Field System may help to lift the sound level of the teacher's voice and distribute it evenly across the room. This can restore an adequate balance between that voice and the accumulation of interfering background noises. As we will see later, care must be taken to limit the amount of "voice lift" in order to prevent a spiral of noise escalation and the loud, louder, loudest effect. And, it will become clear that "voice lift" works best when included with a thoughtful look at other contributing factors from the field of "classroom acoustics".

The term "Sound Field System" derives from the field of audiology. Audiologists enter the frame through their part in the school health programme, examining and caring for the vital communication link formed between teacher and pupil via the speech and hearing process. Audiologists have historically been the key professionals involved in witnessing classroom communications problems and their specialised terminology has therefore been used to describe the proposed solutions. A "sound man" of the old school seeking subtle clarification of the term would call it a sound reinforcement system.

Audiologists have two mainstream ways of assessing hearing. Common audiometric testing uses headphones. The other method, using small loudspeakers in a quiet environment is called the "sound field" method. Therefore, a Sound Field

System means that listeners are hearing loudspeakers rather than using headphones. This is an important distinction when considering the inclusion of hearing impaired children in a mixed class environment. The use of loudspeakers allows all of the children to share the same experience, including not only the amplified sound but also normal verbal communication and other sounds generally around them.

Sound Field System Benefits

Sound Field Systems are becoming more common in the UK. They have been growing in popularity in the United States over the last 10 – 15 years. Some well-documented studies confirm the following about Sound Field Systems and their use:

- During the early years of language development, particularly up to age nine, children do not have the language experience that allows adults to decipher messages amongst interference. The redundant information in speech structures that adults use to understand communication is not yet available to young children, ie, young children must hear and understand more of what is said to them to be able to decode the meaning. Therefore, it is the early years that benefit most from the improved sound distribution that can result from a properly installed Sound Field System.
- Similarly, those for whom English is a second language would also derive a good benefit due to similar language decoding limitations.
- All children benefit from improved speech clarity, not only those with permanent or temporary mild hearing loss. Academic performance has been shown to improve for all class members. Improvements are noted in:
 - on task behaviour*
 - attentiveness*
 - understanding of instructions*
 - less repetition required*
 - better attendance*
 - improved measures of verbal recognition*
- At age four, up to 35% of children may have temporary hearing loss. These children will receive significant additional benefit from a Sound Field System.

Section 8: Sound Field Systems for Schools

- Many children with hearing impairments use personal FM radio aids. These can be linked to the sound field system, which should be designed to accommodate this requirement.
- To obtain the full benefit of improved speech clarity that sound field systems offer, attention must continue to be paid to essential acoustic conditions such as indoor ambient noise and reverberant sound. A sound field system will aid

Fig 8.1 A simple schematic drawing of a Sound Field System in a typical classroom

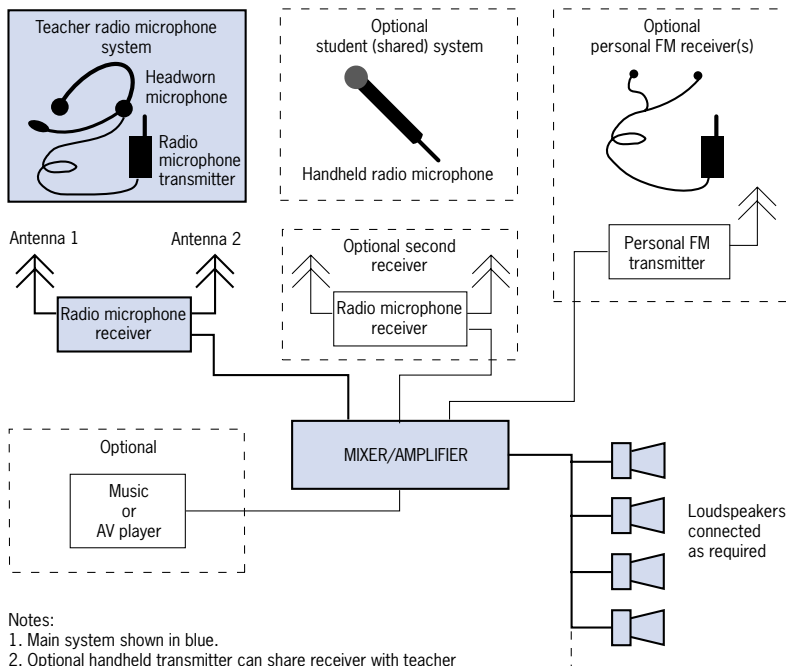

- Notes:
1. Main system shown in blue.
 2. Optional handheld transmitter can share receiver with teacher transmitter. Transmitters must be switched on and off as required.
 3. Alternative second receiver allows simultaneous use of teacher and student transmitters.
 4. Personal FM transmitter(s) for use by pupils with serious hearing impairment can be connected to output of system.
 5. CD, cassette and/or video player can optionally play through the system.

Fig 8.2 A computer model of a classroom showing four speaker layouts, (resulting sound coverage maps can be found at the end of this section). The speakers are drawn horn-shaped to show the directionality of the speaker output. In fact modern speakers can be quite flat.

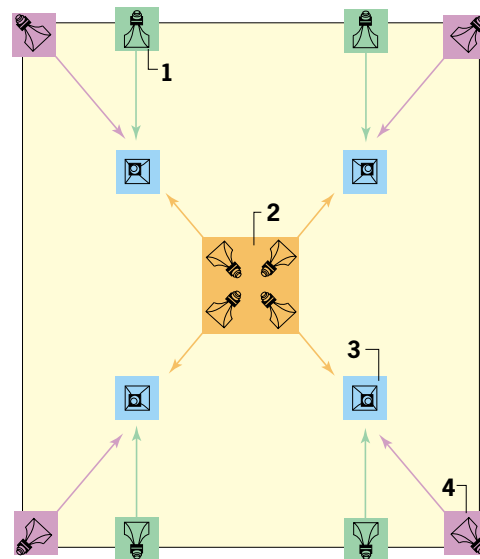

somewhat to overcome noise, but provides the most benefit in a sensible acoustic environment such as is specified in Section 1 of this bulletin. A sound field system WILL NOT overcome problems arising from excess reverberation and usually will not provide much benefit from problems arising due to open plan design.

- When set up properly, a sound field system can actually reduce the operational noise level in a classroom, since discipline is often improved and the teacher's voice can reach all of the children more clearly.
- Recent studies suggest that between 16% and 20% of teachers experience vocal problems during a teaching year. With SFS, teachers find that their voices are less stressed, reducing time lost from vocal strain. In addition, the generally better discipline achievable can reduce other forms of stress also.
- Correct set up, use and maintenance of the system is essential to a successful outcome. Therefore a programme of training new users is absolutely necessary.

Let's consider the essential elements of a Sound Field System and the general requirements for each part of the system. A detailed technical specification for the system elements is given in Appendix 9. This can be used to help generate a specification for purchase.

SYSTEM OVERVIEW

Figure 8.1 shows a simplified block diagram of a typical sound field system. Each element shown can be a separate unit, or some of these can be combined into an integrated unit. As requirements are clarified and installations increase, we can expect manufacturers to create more integrated products, designed especially for sound field use.

Loudspeakers

Working from the listeners backwards toward the source, the loudspeakers form a key part of a Sound Field System. The objective is to select suitable loudspeakers and locate them in the classroom so as to provide the most even distribution of sound throughout the space and to

minimise acoustic feedback or "howl-round". They should also be easy to install, whether in a new-build or retrofit situation.

For convenience, loudspeakers have often been placed on brackets in the corners of a typical classroom, pointing towards the centre. While this works reasonably well, there are other layouts that should be considered. An EASE computer model was constructed to model the effects of different loudspeaker layouts. See figure 8.2. The resulting sound coverage maps have been used to show the effects of interference on speech clarity for the different layouts. See the computer model at the end of this section.

Wall mounted loudspeakers

A basic description of a suitable loudspeaker is that it should be two-way. That means that it contains a larger and smaller loudspeaker within the enclosure that can handle both low and high frequencies. Concentric drivers place the smaller loudspeaker inside of the larger loudspeaker to conserve space and to create a common centre for the sound. Properly designed models are small but excellent for voice reproduction. Another loudspeaker type looks similar, placing a passive "whizzer cone" in the centre of a single driver. This is much less effective since we are still trying to make one loudspeaker cover all of the frequencies. NXT based models (see below for explanation) are also available and could work well.

Brackets should be fixed with more than one bolt to the loudspeaker and both provided with a separate safety fixing so that they cannot fall off and injure people even under most fault conditions. Each individual loudspeaker should sound natural on speech without requiring any substantial tone control adjustments. A set of loudspeakers for use in a room should sound the same in quality and loudness. This is a good, simple test that helps ensure that they are working properly.

Layouts 1 or 4 in figure 8.2 are the recommended placements for wall-mounted loudspeakers.

EXPLANATION OF TECHNICAL TERMS

Matching Loudspeakers and Amplifier

Audio power amplifiers for sound reinforcement are made with two main types of outputs described as "low impedance" and "100 V" or "high impedance". Similarly loudspeakers come in 4 or 8 ohms (low impedance) or 70 V or 100 V (high impedance).

Low impedance amplifiers and loudspeakers

If an amplifier is rated for 2, 4, 8 or 16 ohms, then it is a low impedance type. Care must be taken to ensure that the loudspeakers add up to a total load that is both within the amplifier's power rating (W or watts), and between its maximum and minimum load impedance range. Low impedance speakers, usually rated at 8 ohms for smaller types, have to be connected in a way that creates a total load within the range the amplifier is designed for. High impedance, 100 V or 70 V loudspeakers cannot be used satisfactorily. The advantage of low impedance systems is optimum audio performance, especially at low frequencies. Hi-fi loudspeakers are usually low impedance.

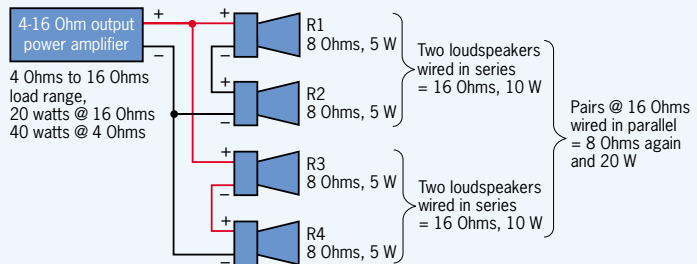

Calculating the load impedance

For loudspeakers wired in series – add up the individual impedances $R_{total} = R_1 + R_2 + \dots + R_N$

– add up the individual power $P_{total} = P_1 + P_2 + \dots + P_N$

For loudspeakers wired in parallel – add up reciprocals of the individual impedance

$$\frac{1}{R_{total}} = \frac{1}{R_1} + \frac{1}{R_2} + \dots + \frac{1}{R_N}$$

– add up the individual power $P_{total} = P_1 + P_2 + \dots + P_N$

In above example $R_1 + R_2 = 8 + 8 = 16$ for each series pair $= R_{1+2}, R_{3+4}$

Wiring the pairs in parallel gives $\frac{1}{R_{1+2}} + \frac{1}{R_{3+4}} = \frac{1}{16} + \frac{1}{16} = \frac{2}{16} = \frac{1}{8} = \frac{1}{R_{total}}$
Therefore $R_{total} = 8$

High impedance, 70 V or 100 V amplifiers and loudspeakers

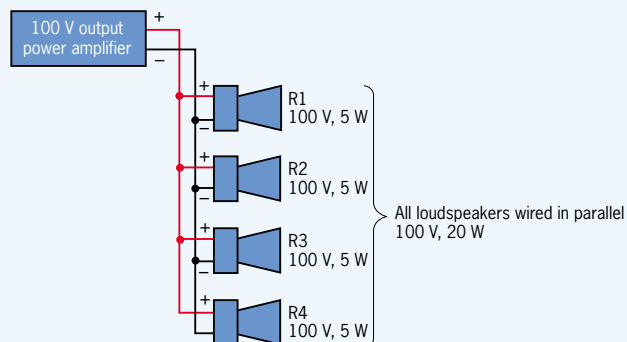

Calculating the load impedance

Impedance is taken care of automatically by the 100 V transformer in the system.

Total power is the sum of all devices connected.

EXPLANATION OF TECHNICAL TERMS CONTINUED

High impedance, 70 V or 100 V amplifiers and loudspeakers

If an amplifier is rated for 70 V or 100 V, then it is a high impedance amplifier. It will also have a power rating. High impedance loudspeakers, rated at 70 V or 100 V must be used. All loudspeakers should be either 70 V or 100 V. In this case the loudspeakers are simply wired in parallel and their individual power requirements are added up. Thus four 100 V loudspeakers rated at 5 W would be wired in parallel and will provide a 20 W load to the amplifier. External transformers can be added to low impedance loudspeakers to convert them for high impedance use. The advantage of this method is simple wiring. PA, paging and SFS loudspeakers are usually 100 V types in the UK.

Radio Microphone System

Compander system (See figure 8.3)

FM (frequency modulated) radio links provide a signal to noise ratio that is determined by the modulation bandwidth of the transmitter. Wider bandwidths allow fewer channels in a band of available frequencies, so regulations limit the bandwidth to two system types described as wideband FM and narrowband FM. Even wideband provides a limited signal to noise ratio of about 65 dB from real products. This is adequate if everything is perfectly adjusted so that a user's voice hits just below the maximum permitted signal level. However real users vary their voices, different users share systems AND they are often not correctly adjusted anyway. A compander system combines a compressor on the transmitter of the system, and an expander on the receiver. The two are matched in their action so that the result on the receiver output is very close to the original input signal. What happens is that a larger signal range of say 90 dB is compressed by 50% to fit into 45 dB. This allows for an improved safety margin in the transmitter so that it does not overload, and allows a wide working range that will tolerate user variations. At the receiver the 45 dB range is expanded again back to 90 dB. This pushes the system noise down and the signal up. The result is a signal free from distortion due to overload and with a much reduced background noise when a soft talker is turned up at the receiver.

Diversity receiver

A FM radio microphone system emits a signal that has a fairly long wavelength. The waves can reflect from room surfaces and arrive at the receiver antenna in a way that causes the waves to cancel. The result is a "dropout" which will be heard as a disappearance of the audio from the system. If the dropout is maintained, for example if the user is standing still in a location that produces a cancellation, the receiver can even hunt and locate an alternative signal to lock onto - though this is uncommon. A diversity receiver provides two independent radio and audio paths, including two spaced antennae. The spacing minimises the risk that both antennas will receive a cancelled signal simultaneously. The unit will automatically and instantaneously select the stronger of the two signals to the audio output.

While audio dropouts may only be slightly disturbing to a person with normal hearing, the hearing impaired child, especially one reliant upon a personal FM receiver will get nothing and could therefore frequently lose the whole meaning or context of a piece of verbal information. Therefore, where possible, diversity receivers should be used.

Ceiling mounted loudspeakers

Where a classroom has a lay-in tile-grid ceiling, whether fitted with acoustic tiles or not, the loudspeakers can easily be

ceiling mounted and the cables hidden within the ceiling void. A plasterboard ceiling is also suitable, but if this is part of the acoustic or fire separation from a room or roof, a suitable rear enclosure must be used to maintain the separation.

Conventional ceiling mounted types can be used by cutting holes in selected ceiling tiles, or newer loudspeaker types that directly replace the tiles can be fitted. Products such as the *Sound Advance* models and various manufacturers' NXT licensed loudspeakers are particularly suitable for ceiling use. They use a newer loudspeaker technology called "distributed mode" to radiate the sound from vibration across the loudspeaker surface, unlike a conventional loudspeaker where the cone moves in and out as a whole. These new types of loudspeaker provide almost ideal properties for speech in most rooms by spreading all of the sound frequencies similarly across the area they cover and reducing the risk of feedback. At the moment there is a cost premium per loudspeaker, but less are required to achieve the same result. In addition, for reasons not yet fully understood, perceived speech intelligibility is often better than when conventional loudspeakers are used.

Layout 3 in figure 8.2 is the recommended placement for ceiling mounted loudspeakers.

A loudspeaker panel at the front of the classroom.

Where the need is temporary, portable loudspeakers can be used. Loudspeakers on stands are not ideal since they are too low relative to the children and teacher. This means that the sound distribution is not even and the teacher may come too close to the loudspeaker – causing feedback (howl-round). An alternative that is often workable is based on the NXT flat panel loudspeaker technology described above. At present these are available in the form of flat projection screens, pictures, etc, that can be hung on the wall and used for more than one purpose. Small to medium sized whiteboard versions are also available. NXT is a licensed technology, so not all

loudspeakers bearing this title may be equal. As usual the advice is to try it before parting with school money.

Audio Amplifier

The next element in the chain is the audio amplifier. For classrooms of typical size, loudspeakers and amplifier can be purchased so that they match each other in a way that makes installation of the system simple. In the typical system shown, four to six loudspeakers are used and they are wired in parallel, being connected to a single cable that goes around the room. There are two methods of providing this matching between amplifier output and the loudspeaker inputs, called low impedance or 100 V line, see 'Explanation of technical terms' for more detail. It is essential that the installer uses the correct combination of loudspeakers and amplifier – not all do. The amplifier must also provide adequate power to the loudspeakers to provide clean sound at the highest sound level wanted. Usually 10 watts per loudspeaker will provide adequate loudness and a safety margin to prevent distortion.

So far, we have assumed that the Sound Field System will be used to lift the teacher's voice above the background noise. But the presence of an amplifier and loudspeakers in the classroom provides the further opportunity to provide playback of audio visual sources. Playing music or video soundtracks benefits from the use of larger loudspeakers (to help deliver the low pitched sounds) and a more powerful amplifier to drive them. While normal classroom usage would probably accept the type of sound that a conventional television produces, specialised teaching spaces, especially those for music, should consider a more powerful Sound Field System that can undertake both its primary function and enhance the musical teaching and learning experience. Care should be taken in the use of more powerful loudspeakers in open-plan areas or in classrooms having poor sound insulation between. In these cases one class may benefit at the expense of another.

Different specifications are required for the two "grades" of loudspeaker and amplifiers – voice grade and "music" grade. See appendix 9 for specifications suitable for normal classroom use.

Radio Microphone System

The next part of the system to consider is the link from the teacher to the amplifier. It is possible to use a wired microphone for this link, but a wireless or radio microphone gives freedom for the teacher to move around the room. The performance of radio microphones is extremely variable, so care should be taken in purchasing this element of the system. Radio microphones also need good routine care, since they are easy to damage and cease to work properly when the batteries get worn.

A typical radio microphone system is comprised of, a microphone to pick up the teacher's voice, a belt worn transmitter that amplifies the microphone audio and then generates an FM (frequency modulated) radio signal, and a portable or shelf-standing receiver that outputs an audio signal again.

Each radio microphone system must have its own transmission frequency. So where multiple radio microphones are in use on a site, it is necessary to have a separate and compatible frequency for each of them. This fact alone might limit the number of classrooms that can be fitted with sound field systems at one site.

The rules for radio aids and radio microphones are subject to almost continuous change. At present a "Radio Hearing Aid" does not require a license, whereas a "Radio Microphone" does require a license. The frequencies of these overlap, so a local church or theatre user might interfere with a school that is very nearby. The latest requirements are published by the Radiocommunications Agency under the category Short Range Devices. The present requirement is called IR2030. The latest information can be found at www.radio.gov.uk. Purchasers should seek assurance from their supplier that any equipment meets current UK regulations and is set to operate on approved frequencies. Where the radio

Section 8: Sound Field Systems for Schools

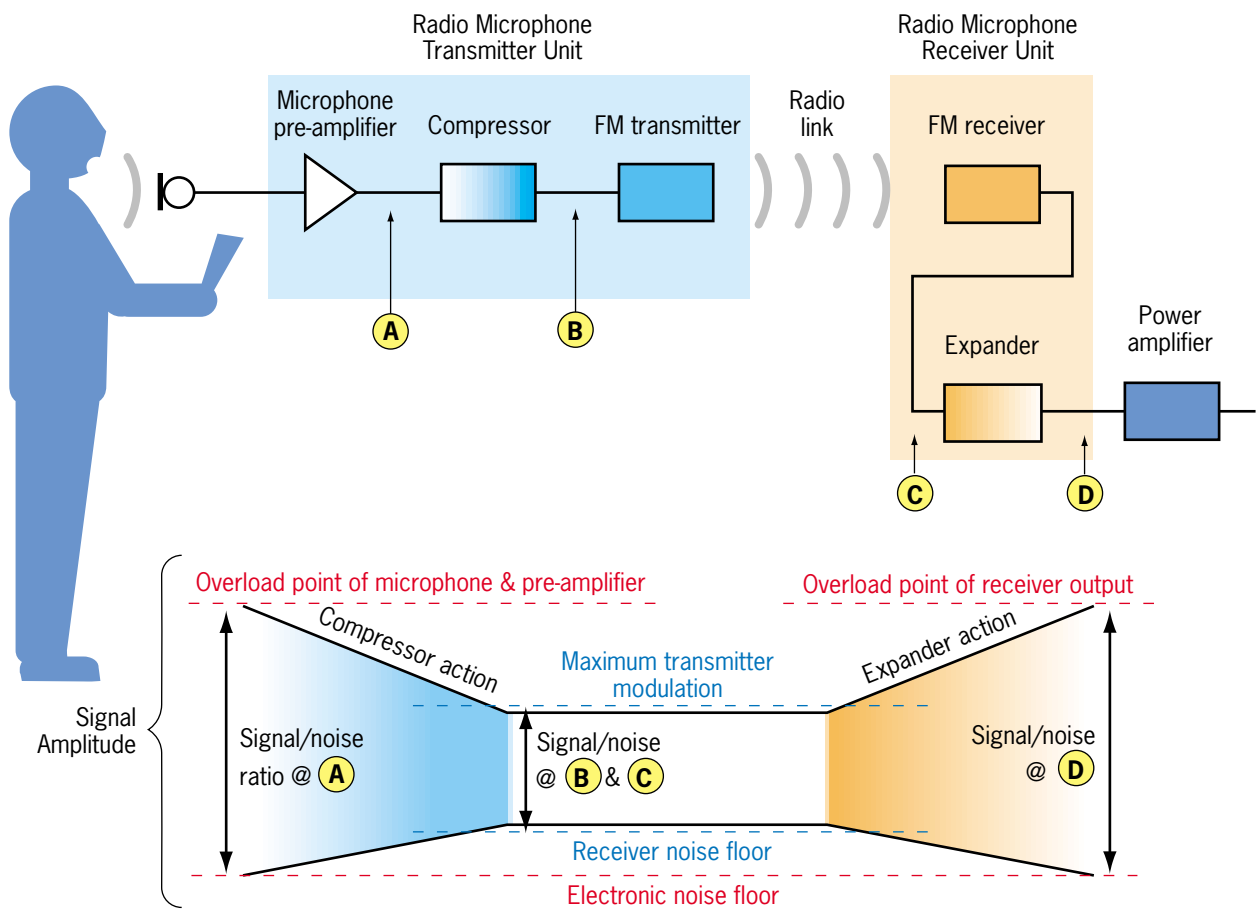

Fig 8.3 FM Radio Microphone System

microphone is used for applications other than as a "radio hearing aid", such as for events in the school hall, a small license fee may be payable. This should be made part of any procurement arrangement and arranged for in maintenance costs.

Key features to look for in a radio microphone system are:

- good battery life – 40 hour (rechargeable) and 120 hour (non-rechargeable) operation periods are quoted, but this is doubtful under real-life conditions in the classroom. Try one before believing published information,
- flexible channel selection – allows multiple radio mic systems to be relatively easily set up and has the benefit of providing easy backup for units which WILL go out of service for maintenance,
- robust construction – including lockable microphone and antenna connectors. DO NOT accept permanently wired-in mics or antennae since these will certainly need repair or replacement regularly. Also important is provision for easy battery changing with little risk of

breakage of "clip-on" style battery connectors. It is better that the battery just slips into place.

- compander system – this provides a large signal to noise ratio at the receiver, allowing a good tolerance in setting up the system. Non-companded systems are easily mis-adjusted, generating excessive "white noise" on the audio output, or alternatively audible distortion. A simple non-companded system is acceptable for use as a personal radio aid where the user is fully trained in correct adjustment.
- diversity reception – this uses two antennae to receive the FM signal, switching to the one with the highest signal at any moment. These are helpful because the radio waves used are very short and reflections can cancel at the receiver, but not usually at two spaced aerials at the same time.

In urban environments where a large number of radio systems may be in use locally, experiments or a radio signal survey should be undertaken before purchasing the equipment.

The Microphone

The teacher will usually wear the microphone and transmitter during normal classroom activities. The choice of microphone and the choice and positioning of loudspeakers are the two most important factors in achieving good sound quality WITHOUT feedback. For a Sound Field System, a headworn microphone is recommended as this will keep the microphone element very close to the teacher's mouth, even when he/she turns their head. The microphone should have a wide frequency response that is relatively flat with perhaps a small peak between 1 kHz and 3 kHz. The microphone should be omni-directional (picks up sound all around) or directional with a nearfield correction filter inside. This is because the use of a directional microphone at very close distances causes a rise in the low frequencies that can produce a boomy sound that reduces the intelligibility of speech.

Headworn microphones are available that clip over the user's ear, or are supported around the back or on top of the user's head. Ideally, users should have the opportunity to experiment with different types and select that which is most acceptable for their head shape and range of activities. Another suitable microphone has a flexible stem, allowing it to be wrapped around the shoulders to suitably position the microphone near the mouth. However, unlike a headworn mic, this does not follow head movements.

Where it is desirable to allow students to participate in a discussion using the Sound Field System loudspeakers, a handheld microphone can be plugged into the transmitter instead of the headworn microphone. Alternatively, a separate integrated handheld transmitter may be used if the teacher's transmitter is switched off. It is not possible for more than one transmitter to be used simultaneously with one receiver.

SETTING THE SYSTEM UP

A Sound Field System is not intended to be loud, but rather to be as soft as possible while still providing clear speech

that is well distributed across the classroom. The teacher can learn to regulate the effective loudness by raising and lowering their voice, just as they would do without a Sound Field System.

The ideal method for setting a system up is to measure the background noise in the classroom during normal conditions (ie, with a class present) using a Type 2 or better sound level meter. A meter providing L_{Aeq} (equivalent continuous) measurements is most suitable. Another name for this is a "noise dosimeter". The teacher can then talk in an average voice level and adjust the sound of their voice to be in the range 10 dB to 15 dB above the measured background noise level. The recommended loudspeaker and amplifier ratings should then allow the teacher to use a raised voice without distortion, or use a subdued voice without the evidence of system noise.

The recommended adjustment process is as follows:

- Measure the background noise for five minutes or so during a relatively noisy part of the day, but not at a time where the noise is unusually loud. Often this will be during the beginning of the day when traffic noise is highest, or during periods when some classes are in the playground and making noise that enters the classroom. If clear instruction has to be given during noisy class activities, then measure the noise under those conditions. Write down the result.
- Fit the headworn microphone and adjust the element to about 25 mm to 50 mm from the mouth. Find a comfortable operating position.
- Use a raised voice to adjust the TRANSMITTER level (if present) so that there is no audible distortion on the system. If the radio microphone system has a meter, adjust the TRANSMITTER level (or gain) so that the display stays just below the red range. This ensures that the microphone and transmitter are working optimally for the individual user.
- Reset the sound level meter if necessary. Now reduce the vocal effort to achieve a normal speaking voice for classroom use. Sound Field Systems do not have the magical ability to produce

suitable sound from a poor source. Do not talk especially quietly, but rather use a normal voice.

- Adjust the AMPLIFIER volume (or gain) to give a sound level reading that is approximately 15 dB above the background noise when measuring at various locations in the classroom. Remember that the meter averages the measurement over time, so spend a minute or two at each of several locations and note down the results, resetting the meter between locations. At each location read the same material with about the same vocal effort, so that the results will relate to each other properly.
- The result will not be the same everywhere, but should remain approximately in the range 10 dB to 15 dB above the previously measured noise level. This ensures that the receiver audio output level is suitably adjusted to provide the required sound level in the classroom. If the sound seems too loud, then do reduce it a little. Alternatively if it seems too quiet, then turn it up a little. The objective is a comfortable classroom that provides easier listening for the children and easier talking for the teacher.
- Starting with any tone controls at their neutral position, vary these as little as possible while talking so as to achieve clear, natural sounding speech for the listeners. Extreme adjustment usually means a mis-operation, miswiring, poor equipment or a fault.
- Move around the classroom into the various locations that you might use and confirm that feedback does not arise. If the microphones and loudspeakers are suitable for their purpose, then there should be a safety margin of about 10 dB when using a good quality headworn microphone.

Use with Music Systems

Many amplifiers will provide a switchable input to allow music to be replayed via the Sound Field System. But, the most helpful system will allow the music to be mixed with the teacher's voice so that they can comment on the music using the system at the same time that the music is playing.

Use with Personal Radio Aids

For many children with chronic hearing loss, personal radio aids will still be required in the classroom to provide them with the best listening environment adjusted specifically to correct their hearing deficiency. Where a Sound Field System is in use, it is best that the two systems are interconnected rather than requiring the teacher to use two transmitters and microphones simultaneously.

There are two ways that a Sound Field System can work with a Personal Radio Aid. The first requires that the radio aid receiver channel can be switched to match the teacher's transmitter. They must also be compatible in other ways, including the use of a compander, "pre-emphasis" which is equalisation used to improve the noise performance of the system, and the same modulation bandwidth. Where the school supplies both systems and the supplier co-operates, this is a good way to go.

Alternatively, the student's personal transmitter is plugged into the sound field system receiver or amplifier audio output so that it works as a completely separate radio link. This method requires different radio frequencies for the two systems, and they must be compatible. These methods are shown dotted in on Fig 8.1.

Where a large number of sound field systems are in use within a single school or site, the limited number of radio channels (frequencies) introduces new problems. There are only a limited number of license-free radio channels, 22 at the present time in what is called the VHF high band from 173.3 MHz to 175.1 MHz at 50 kHz centres. These are unlikely to all work together simultaneously, so some adjacent classrooms could interfere at first. An alternative frequency band called UHF from 863 – 865 MHz is available with a modest licensing cost. Most personal radio aids work at a limited subset of radio channels sharing the VHF high band channels mentioned above and these too must be accommodated. Discussions are taking place with manufacturers about development of hybrid radio and infra-red

systems that will allow any child to take a personal wireless aid from room to room without interference. In the short term, for a large number of installations on one site, seek expert advice – probably from more than one supplier – before going ahead.

Use with Audio Frequency Induction Loop Systems (AFILS)

Audio frequency induction loops provide an electro-magnetic signal that can be picked-up by any hearing-aid provided with a T-switch. It is possible to design an AFILS system so that good quality is received by hearing aid users, though not as good as a Personal FM Radio System can provide. However, AFILS will leak between adjacent classrooms, so should not generally be used where students move between rooms or where there are a number of hearing impaired users in different rooms on one site. Such a system could be helpful, however, in the school hall, where many hearing aid users may be present at once, including parents and grandparents. In fact, an AFILS or alternative provision for the hearing impaired such as an infra-red system is required for any room with a floor area over 100 m² by the Building Regulations.

What to do if problems arise!

Poor sound quality, a ringing sound or outright feedback can as easily be produced due to equipment defects, poor installation, cabling faults, etc, as it can arise from poorly designed equipment.

Batteries

Rechargeable batteries do not last forever and will work for shorter periods as they age. New non-rechargeable batteries can have manufacturing defects and perform poorly straight out of the box. Flat batteries are the single most common fault found with radio microphone equipment. Change these first or test in a known working unit.

Microphone and Antenna Leads and Connectors

The second most common fault arises

from faulty cables and connectors. These WILL fail after a time, so spares should be kept to allow immediate replacement and test. Keep cables straight or gently curving, avoid kinks and sharp bends. If the insulation gets frayed, repair immediately. Microphone elements can also fail or deteriorate due to aging, spittle, food particles or mechanical damage. Keep a windshield (pop gag) over the element and keep a spare. Windshields are cheap and can help keep the microphone element clean, while minimising the "popping P" from the audio output.

Feedback or "howl round"

Acoustic feedback arises when the sound from the loudspeakers recirculates around the system by being picked-up on the teacher's microphone. The risk of this common ailment is best reduced during design. Key points are:

- the quality of the loudspeaker (even sound coverage with no "peaks" in the frequency response in any direction),
- choosing loudspeaker locations that minimise their interaction with each other and room surfaces as these can produce peaks in unexpected locations,
- the quality of the microphone (similar to the loudspeaker requirement),
- the nearness of the microphone to the source (the reason for using a headworn microphone),
- the "liveness" of the room (excess reverberation raises the risk of feedback), and
- the sound level that the system is set to.

Calculations indicate that good equipment, installed as recommended, will provide adequate sound output without feedback. But sometimes even when great effort is applied to the selection and location of equipment, feedback will still arise. In these cases, an external feedback eliminator may be fitted between the radio receiver and the amplifier. This can semi-automatically "tune out" the troublesome frequencies and get a problem room to behave acceptably. They are, however, relatively expensive and can be tricky to use.

Adding more diffusion (shelves with

Section 8: Sound Field Systems for Schools

books and boxes are useful) to scatter the sound reflecting from large surfaces can be a help, as can the addition of a carpet, acoustic ceiling tiles, pin boards for display, or a wall hanging or two.

Other Funny noises

Swishing sounds, "dropouts" where speech intermittently disappears, and other funny noises are often related to radio interference or battery failure. FM radio receivers have the property of locking onto the largest signal they receive within the channel they are set to. It is possible for a high-powered handheld "walkie-talkie" to break into a radio microphone receiver. More commonly, battery power drops and radio transmitter power with it, leaving the receiver searching for and finding an alternative signal to lock onto. For this reason a transmitter should never be turned off, since the receiver will often find an alternative signal to receive instead.

Rather, MUTE the transmitter audio while leaving it turned on if visiting the toilet or chatting in the corridor to colleagues. This will also reduce the risk of other funny noises or comments being broadcast. The alternative where the transmitter does not provide for audio muting is to turn off the receiver or amplifier when the system is not to be used.

Persistent problems

If problems persist, assume that there is a defect and request the supplier to sort it out. It is recommended that suppliers are not paid in full until the system is proven to work to the user's satisfaction. Once a system is accepted and paid for, a service agreement can provide a fixed cost of support for budgeting purposes. It should however be born in mind that support begins by correct staff training and keeping a few spare parts in working condition. This is the cheapest and most effective insurance against system failure.

Computer model of loudspeaker positions in a classroom

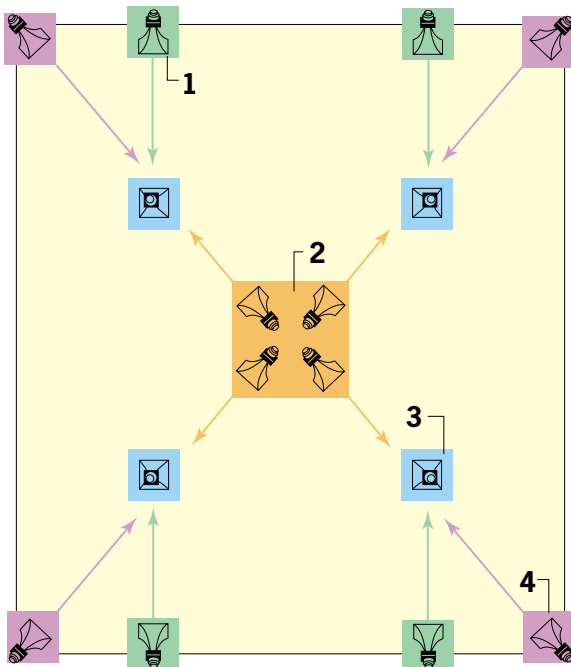

An EASE computer model shows the sound coverage for several possible loudspeaker layouts in a typical classroom of dimensions 7 m x 8 m x 2.6 m. Finishes are industrial hard wearing carpet flooring, plastered brick walls and a plasterboard ceiling. The interior reverberation has not yet been modelled. The following four loudspeaker configurations were tested:

1. Four loudspeakers mounted 1/4 of wall length from the end of the wall. Mounted flush with the wall, at 2 m height, aiming at the floor about 2/3 distance of room from the wall.
2. Four loudspeakers mounted at the centre of the room, spaced by 600 mm in a square orientation, aiming at the room corners
3. Four loudspeakers mounted flush with ceiling, facing directly at the floor, in the centres of 4 quadrants of the ceiling.
4. Four loudspeakers mounted in room corners.

The loudspeakers are good-quality two-way cabinets using a front loaded 4" bass and 1" tweeter. They have a wide coverage angle and a smooth, relatively flat frequency response down to about 125 Hz. The JBL Control 25 was used for the example shown.

The loudspeakers were aimed to provide the best direct sound coverage with interference effects turned off, ie, loudspeaker interference with each other was not considered in initial aiming.

The estimated sound coverage pattern was then modelled for each loudspeaker setup using pressure summing only (no interference). This is the way that most designers and contractors/installers think about loudspeaker installation. The results at 1 kHz are shown on the left for each case, on the following page.

Then a complex result was calculated for each loudspeaker setup. This reveals amplitude peaks and dips that result from both spreading loss of the loudspeaker output with distance, and cancellation/summation effects that result from the phase change of the loudspeaker output with frequency and distance. These are shown on the right for each case.

Interpretation

A level change in the direct sound level of 6 dB (+/- 3 dB) is usually considered to provide good sound coverage. This can be read as six contours on the mappings.

It can be seen from the data mappings that acceptable coverage is provided by all four layouts when only the left hand result is examined. Thus all of the options could be considered to be okay on that basis.

However, when complex summing is turned on, additional peaks and dips appear in the combined loudspeaker response. In some cases the peaks are higher for locations off axis of the loudspeaker than they are on axis. In addition, it will be noted that some frequencies are strong in one location and other frequencies in another location. This implies that as a listener moves around the room they will hear a changing tonal balance that could range from "muffled" where the lower frequencies predominate to "hard or brittle" where the higher frequencies are louder. Especially in the "muffled" zones, speech clarity would be expected to suffer.

Another effect of this is that the higher sound level areas will produce a higher sound signal into the teacher's microphone at a specific range of frequencies. The loudspeaker may not even appear to be pointing that way. Feedback could arise that would cause confusion to many people trying to identify and solve the problem.

The examples demonstrate clearly that loudspeakers interfere with each other in ways that are not immediately obvious and that the resulting changes in the frequency response at each point could compromise both speech clarity and increase the risk of feedback.

In many ways the examples shown are simplified. Very narrow contour changes may not be audible but could produce feedback in a passing microphone. Note that the interference shown only accounts for the four physical loudspeakers. When loudspeakers are flush mounted, then only the physical loudspeakers need to be considered. Where loudspeakers are mounted near a surface or surfaces on a mounting bracket, then an additional "image source loudspeaker" is created corresponding to the reflection of the loudspeaker wave from the wall. Thus, the surface mounting examples below actually generate even more complex interference patterns than those shown in these examples.

Results

Case 1 causes some peaks in the room, but these are similarly located at different frequencies and have narrow contours. This is likely to work reasonably well.

Case 2 produces the worst effects in the room and is not recommended.

Case 3 produces the most even coverage at all frequencies and the least loudspeaker interaction.

Case 4 also provides relatively even coverage of the room with interference effects that would appear relatively benign. However, location of loudspeakers in the room corners produces the most complex "image sources" and will also tend to produce a rise in the

Section 8: Sound Field Systems for Schools

bass response of the systems. The bass rise will usually require equalisation using system tone controls to produce optimum speech clarity and naturalness.

Case 1: 1000Hz
Direct field pressure summation only



Direct field with complex summation

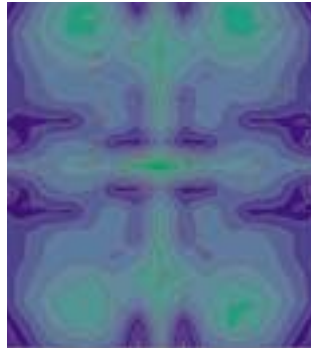

Case 2: 1 kHz
Direct field pressure summation only

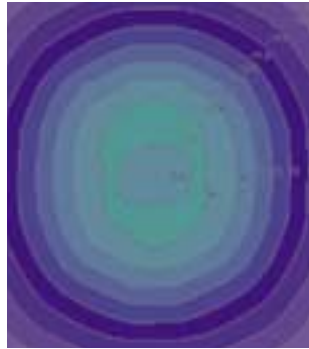

Direct field with complex summation

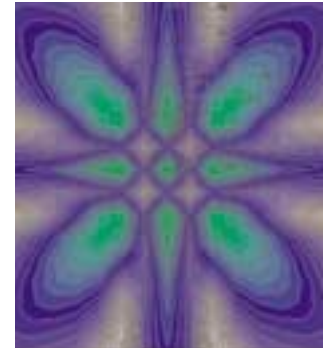

Case 3: 1 kHz
Direct field pressure summation only

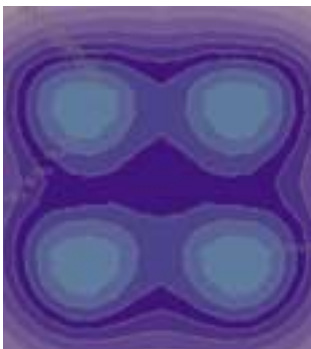

Direct field with complex summation

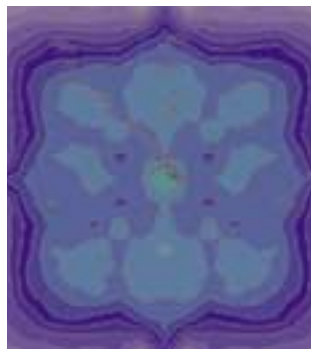

Case 4: 1 kHz
Direct field pressure summation only



Direct field with complex summation

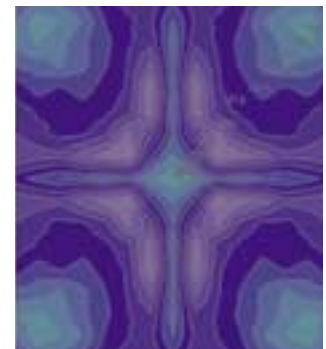

KEY

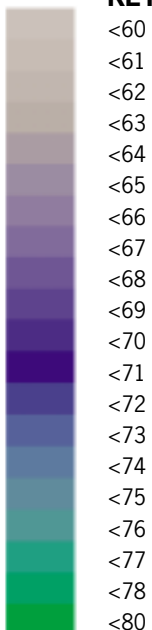

Recommendations

Case 3, which uses ceiling mounted loudspeakers, is recommended for all rooms where a drop-in ceiling exists. Loudspeakers should be selected to provide a wide and even coverage that is constant with frequency. Suitable devices for consideration are Sound Advance CT8B, Amina APP Series PowerPlus Acoustic Ceiling Tile Loudspeaker (NXT licensee) or Armstrong I-CEILINGS™ SOUND SYSTEM (NXT licensee). Alternatively, conventional ceiling mounted loudspeakers can be used, but these must provide a frequency response that is smooth and wide coverage from 200 Hz to 4 kHz.

Cases 1 and 4 using wall mounted loudspeakers are recommended where ceiling mounted units are not practical. Location at least 1 m from a corner at minimum 2 m above the floor, but located down from the ceiling by a minimum of 600 mm is recommended. Brackets should otherwise keep the loudspeaker very close to the wall to minimise self-interference effects.

APPENDIX

Detailed technical equipment specifications for use in procurement of Sound Field Systems are included at Appendix 9.